

JSF F-35C (Navy Version)

Mini-Park Jet

by hawker@comcast.net

18" Wingspan - 22" Length
For Feigao 12mm Brushless Motor
340mAh Kokam Lipoly Battery
2 Servo's for Elevon/Aileron Control
AUW Approx 4 oz's

Very exciting jet like performance

Cut each side from 3mm Depron

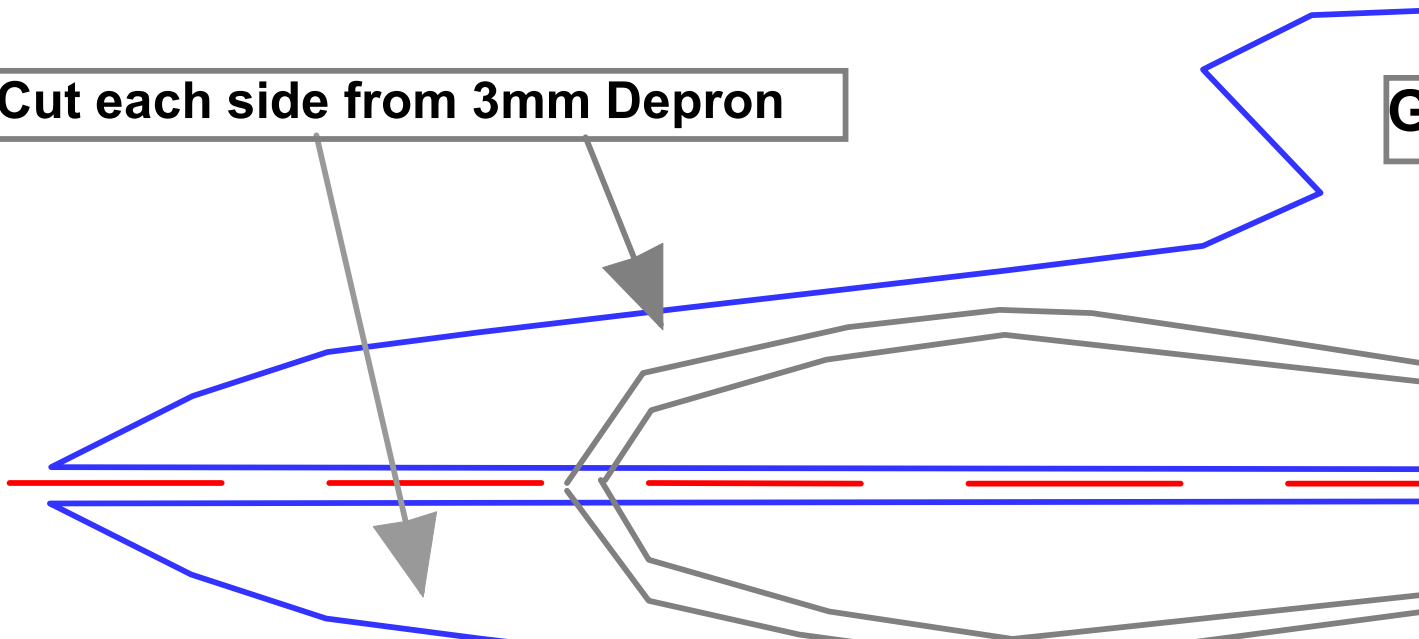

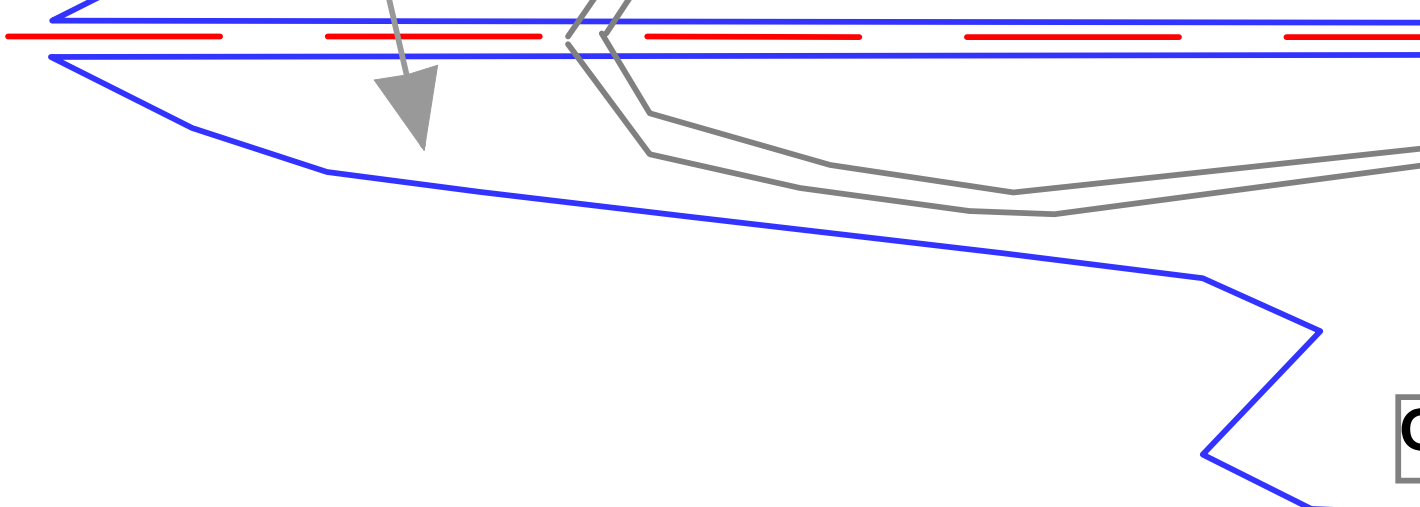

If you have as much fun flying this wonderful jet as I have, please make a \$10 donation to support more models! I have many idea's that are forthcoming and the next one will be very similar power wise - and just as exciting to fly.

Send Any \$10 Dollar Paypal Donations to:
hawker@comcast.net

While certainly not required - all will be greatly appreciated and provide inspiration to produce more plans.

Thanks very much!

Pete Hawk

Watch this video of it in action!

Video link: <http://www.putfile.com/media.php?n=F-35C-Mini-Jet>

**0.5" White Foam or 6mm Depron
Flat Fuselage Profile**

**Carefully cut slo
main wing**

**0.5" White Foam or 6mm Depron
Flat Fuselage Profile**

**Carefully cut slot
main wing**

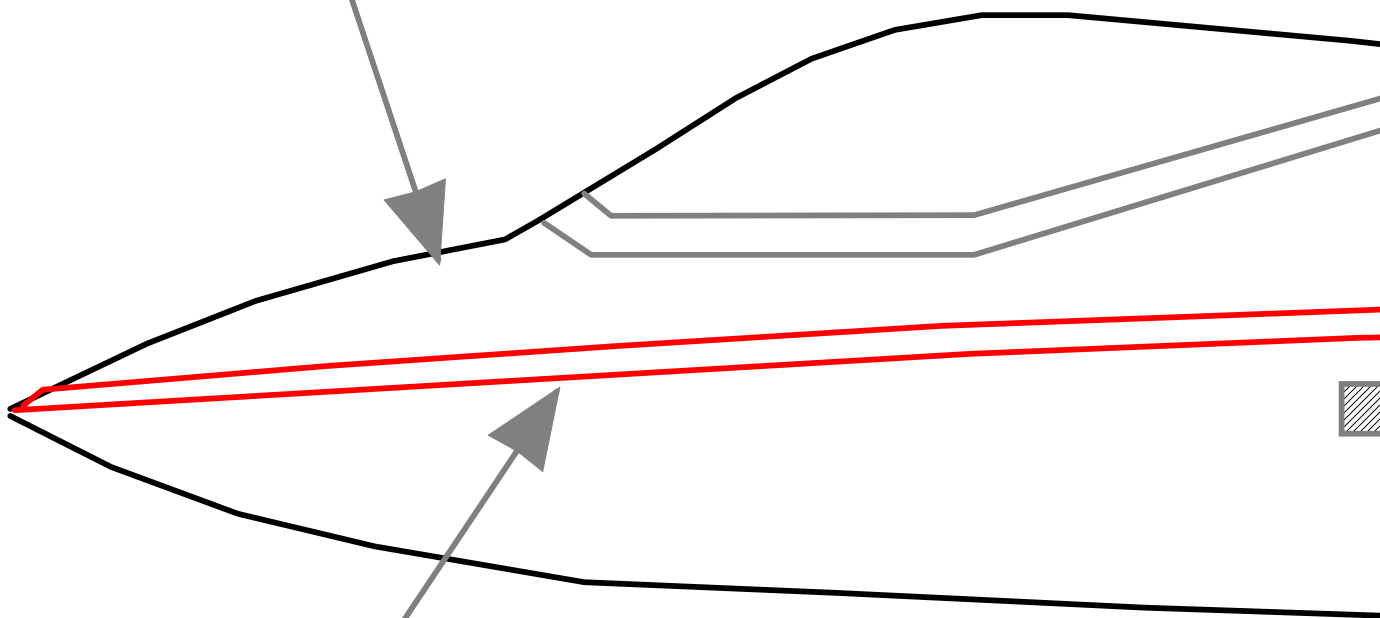

**Lightly Epoxy 3mm forward fuselage
sides to main profile**

**Cut slot as shown
Kokam Lipo B**

ersion)

.net

length

ss Motors

Battery

n Coupling

s

ormance!

18" Wingspan - use 6mm
Depron

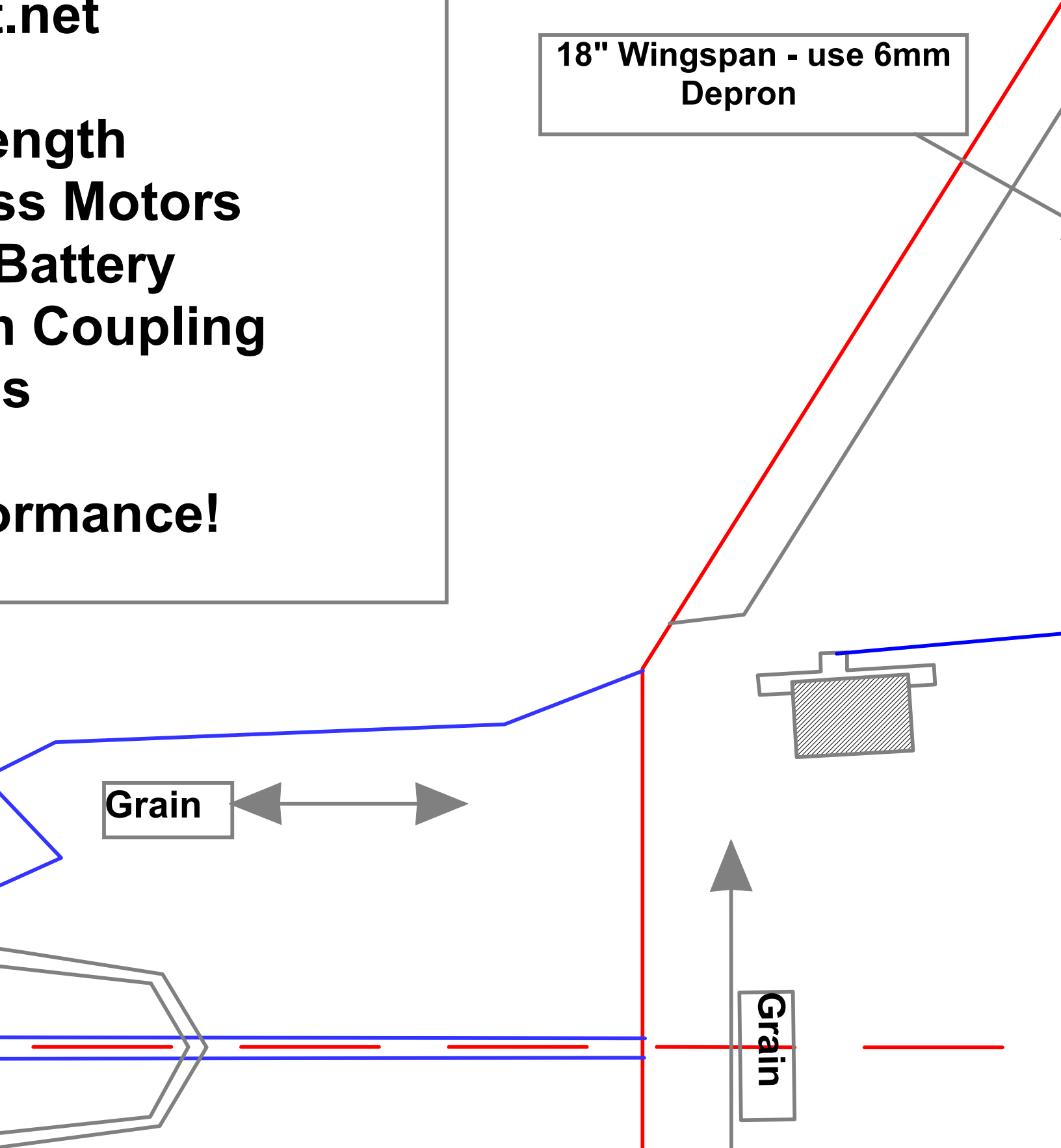

Grain

Grain

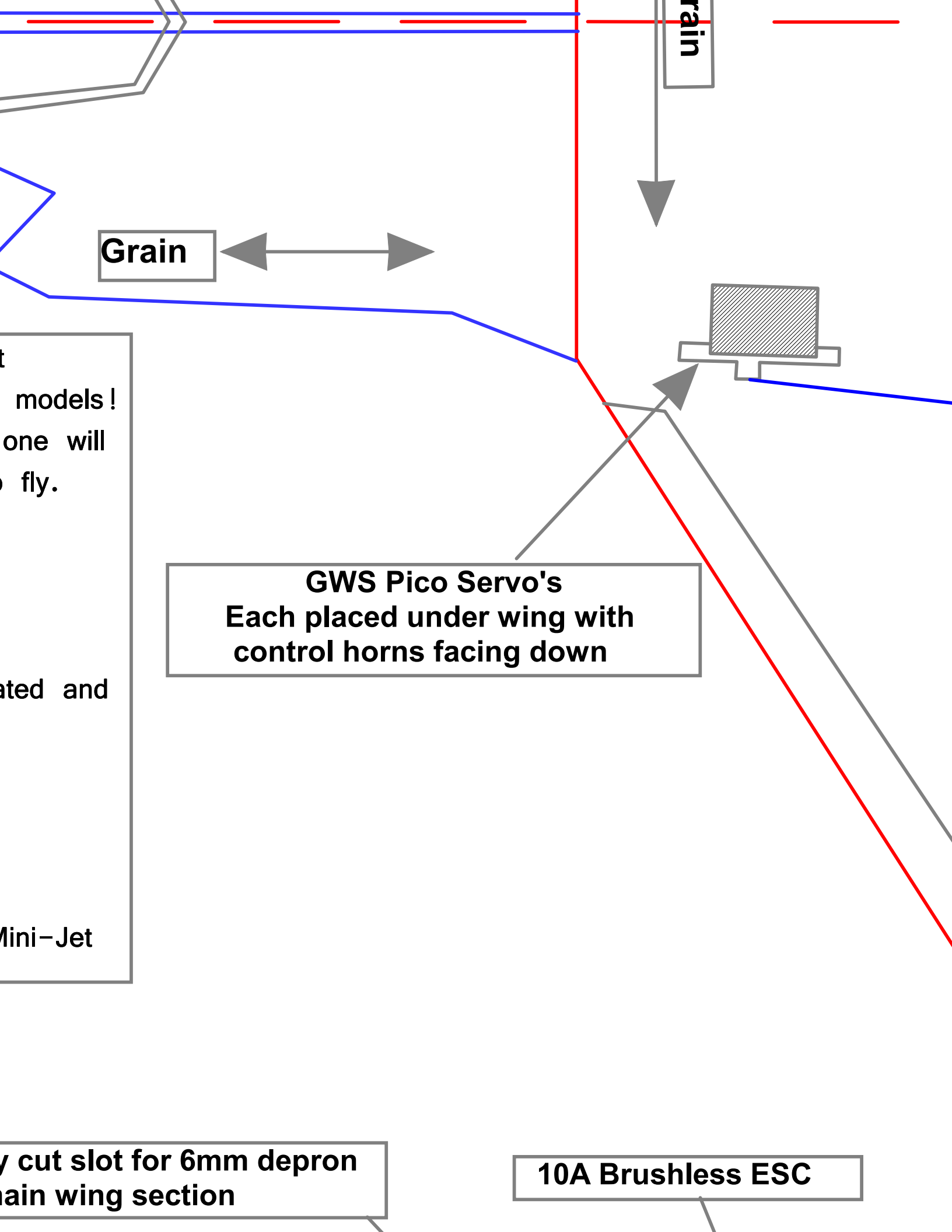

rain

Grain

t
models!
one will
fly.

ated and

Mini-Jet

GWS Pico Servo's
Each placed under wing with
control horns facing down

10A Brushless ESC

y cut slot for 6mm depron
main wing section

cut slot for 6mm depron
main wing section

10A Brushless ESC

Feigao E
Mo

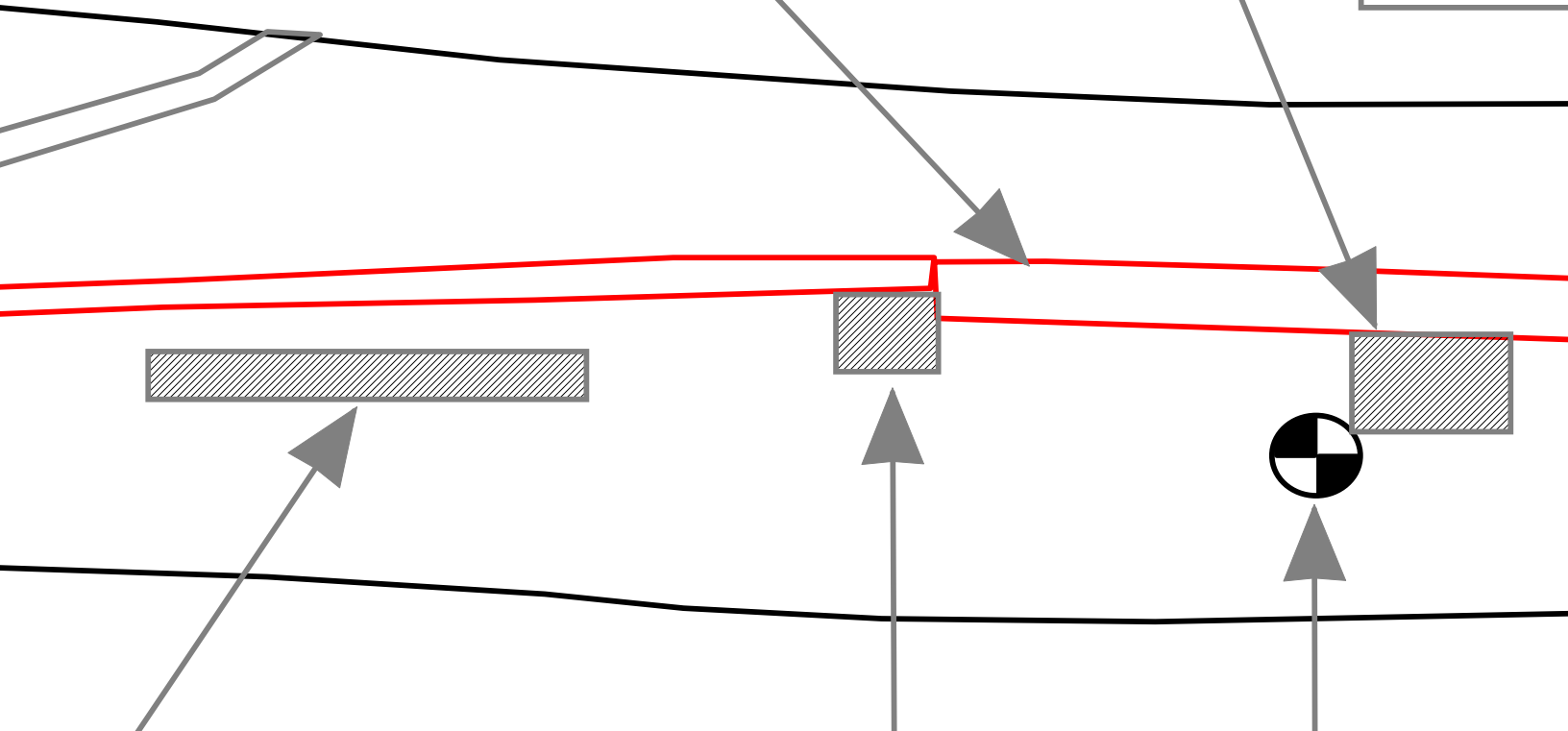

shown for 340mAH
Lipo Battery

GWS 4Channel Pico
Receiver

CG

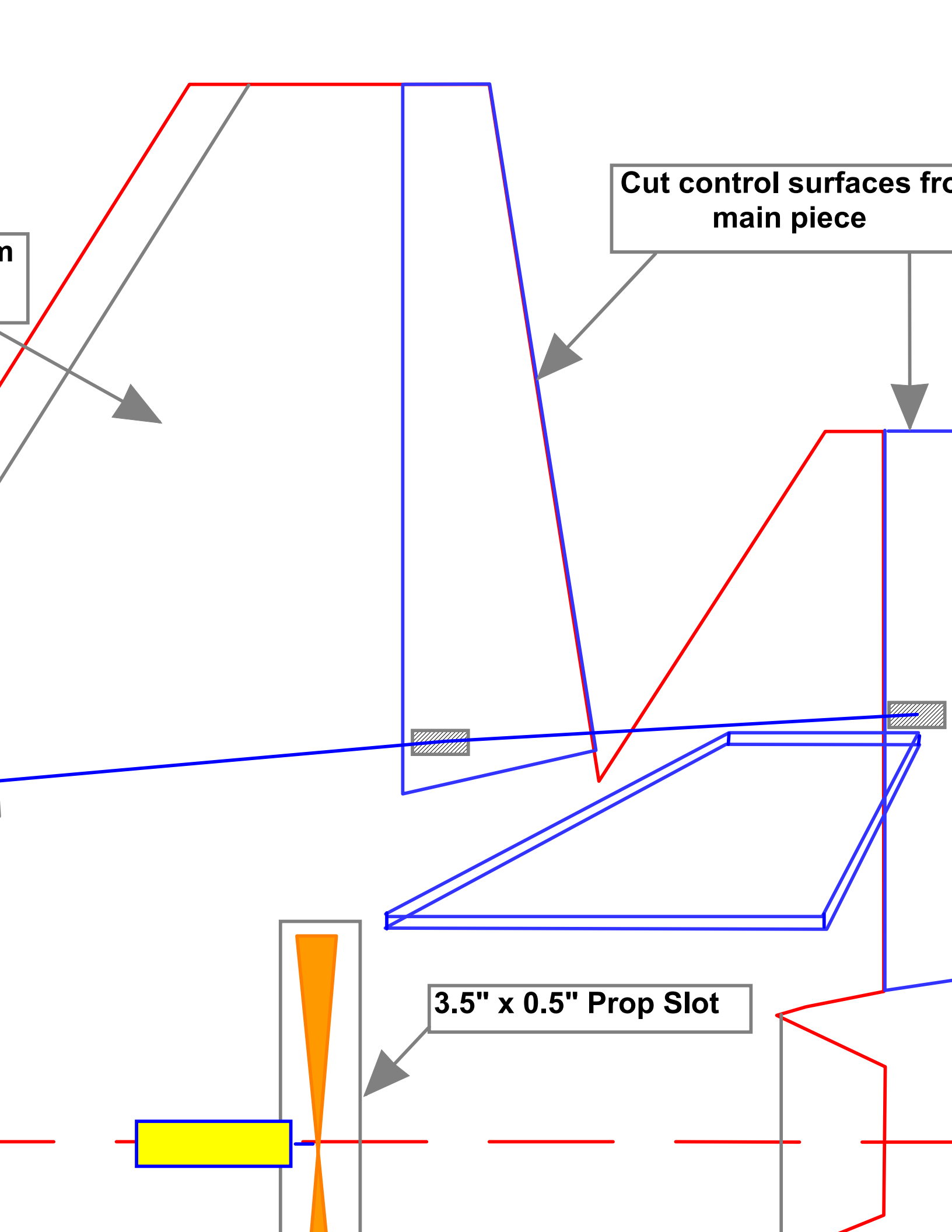

m

Cut control surfaces from main piece

3.5" x 0.5" Prop Slot

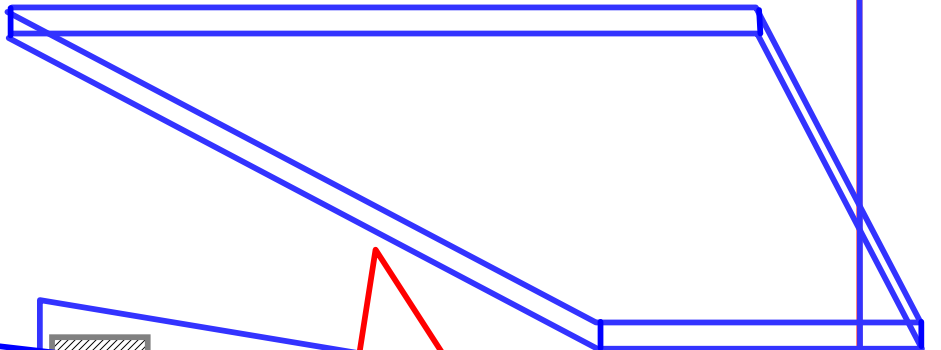
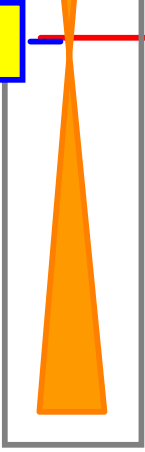
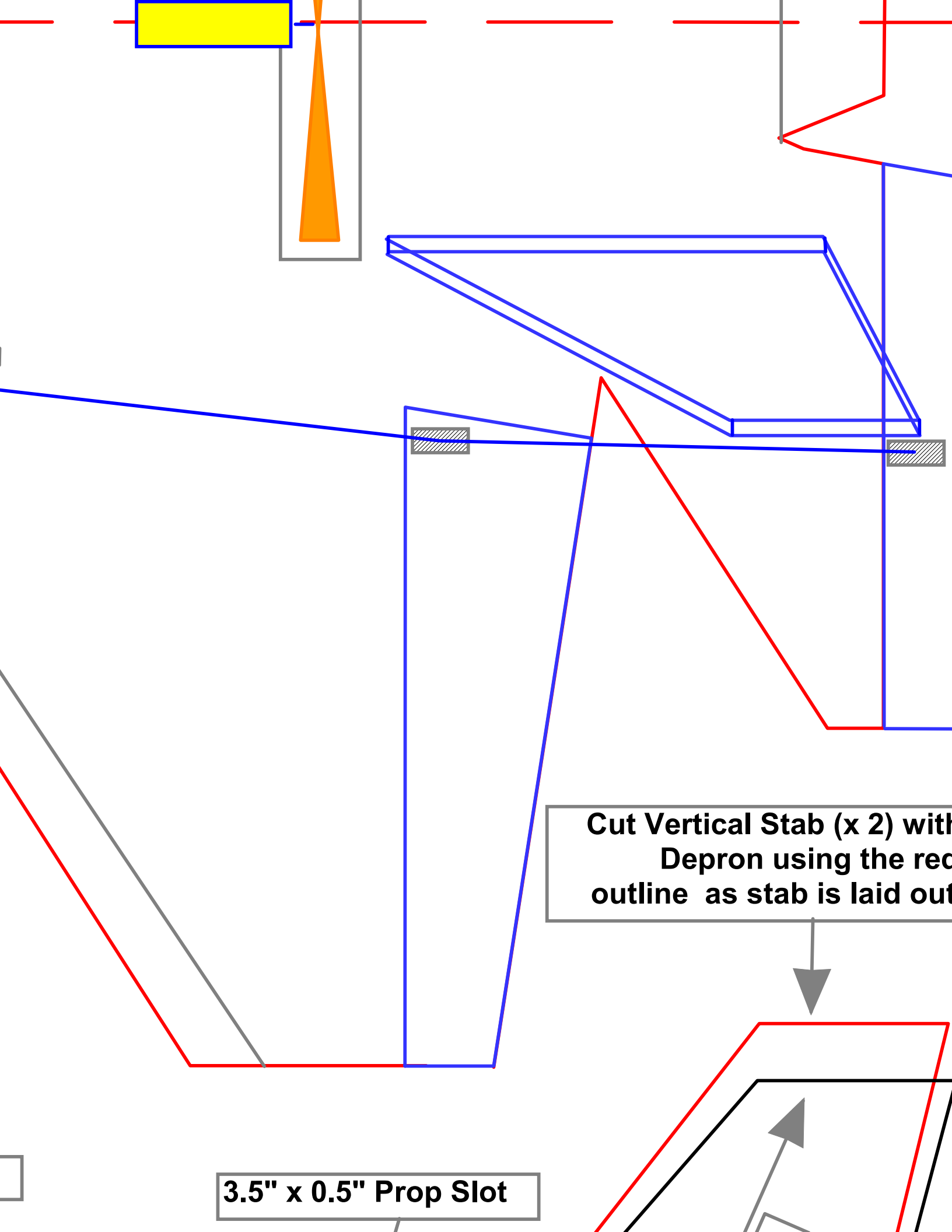

Cut Vertical Stab (x 2) with Depron using the red outline as stab is laid out

3.5" x 0.5" Prop Slot

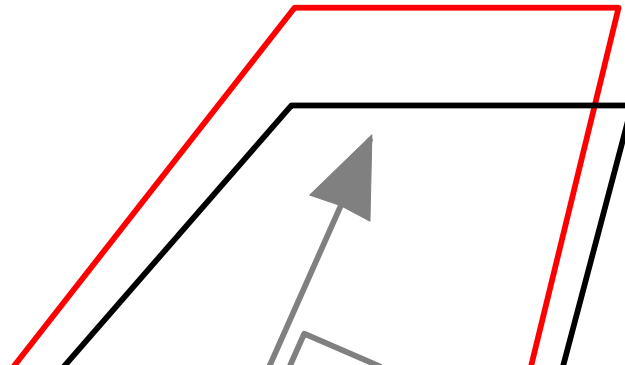

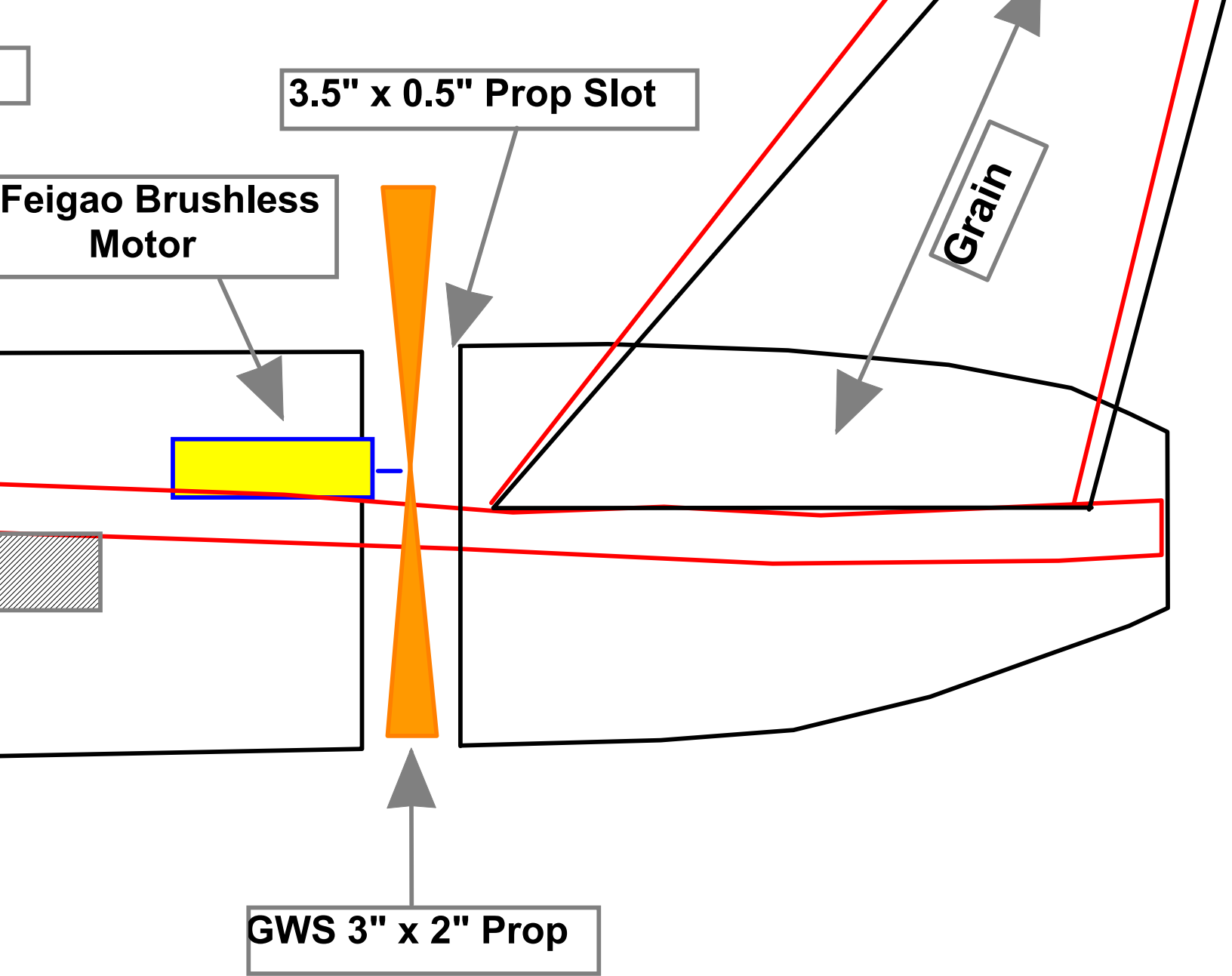

faces from
ce

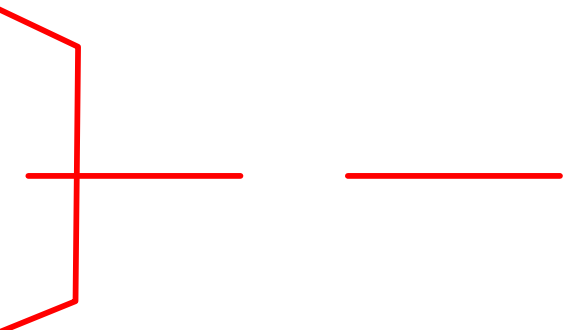
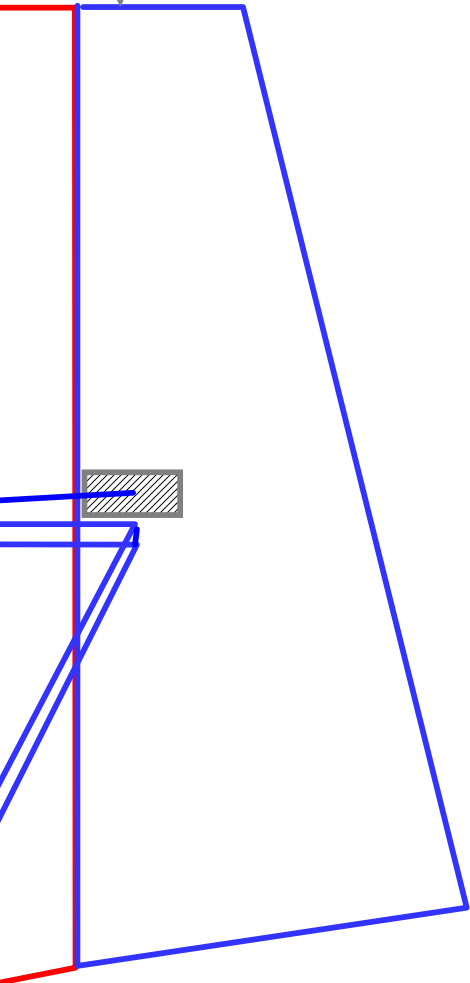

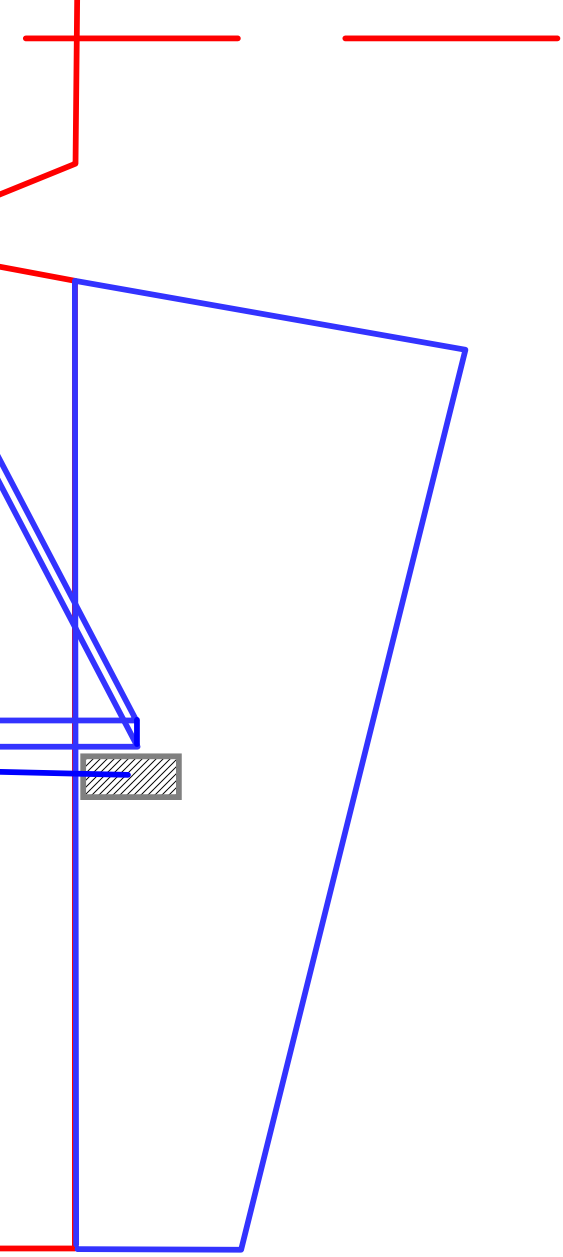

(x 2) with 6mm
g the red
laid out flat

