

Rail x2

Throws

Pitch: .8" each way
Roll: 1" each way

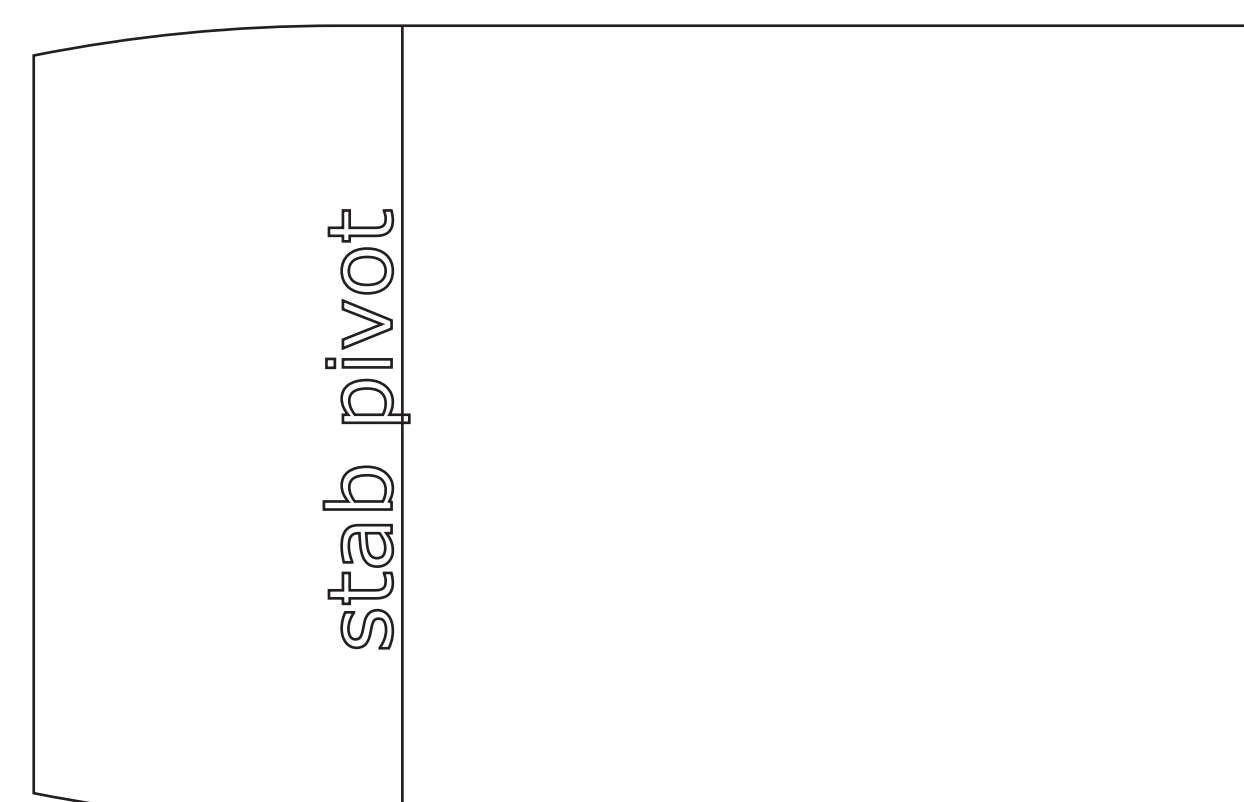

stab pivot

23.60

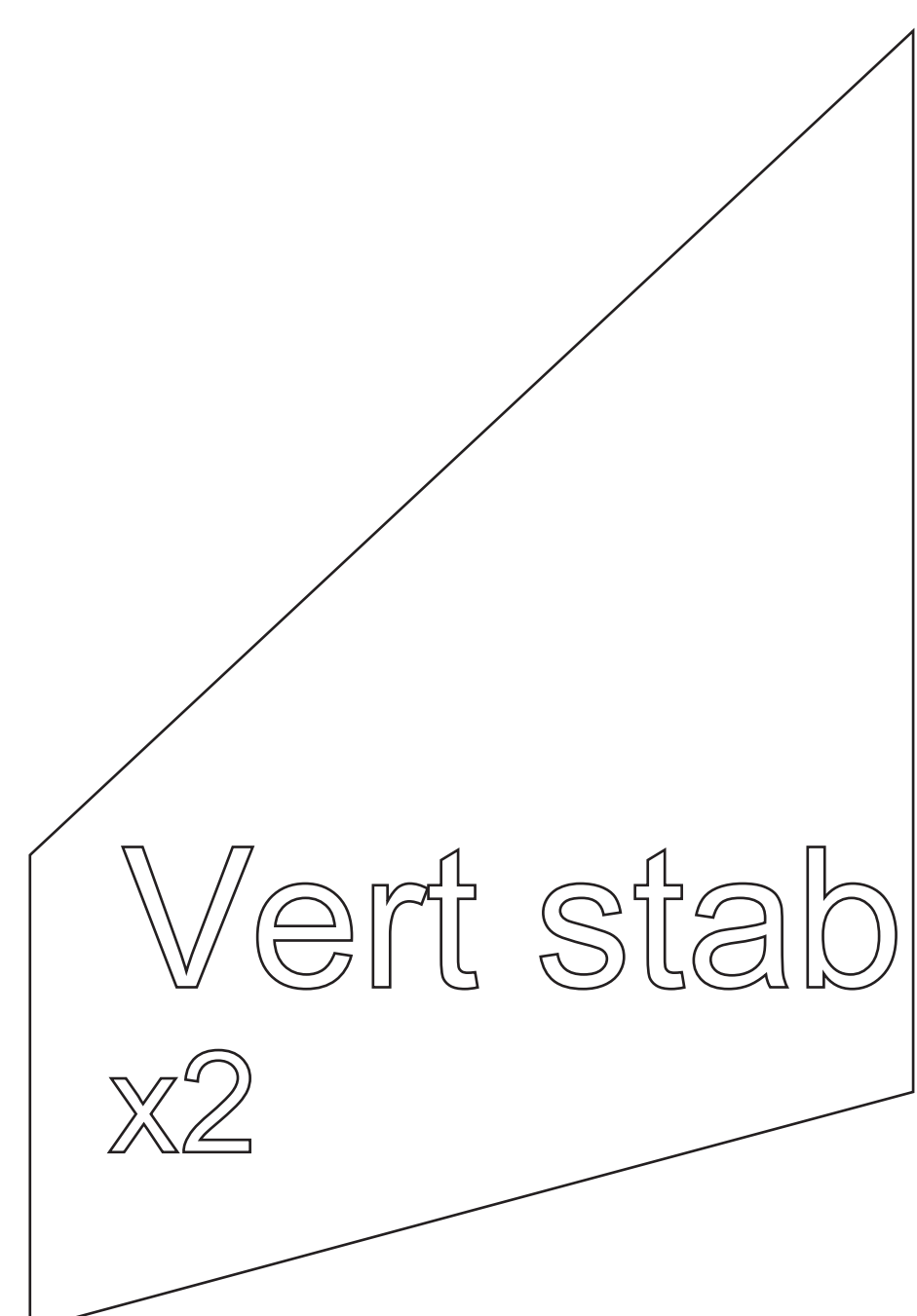

Vert stab x2

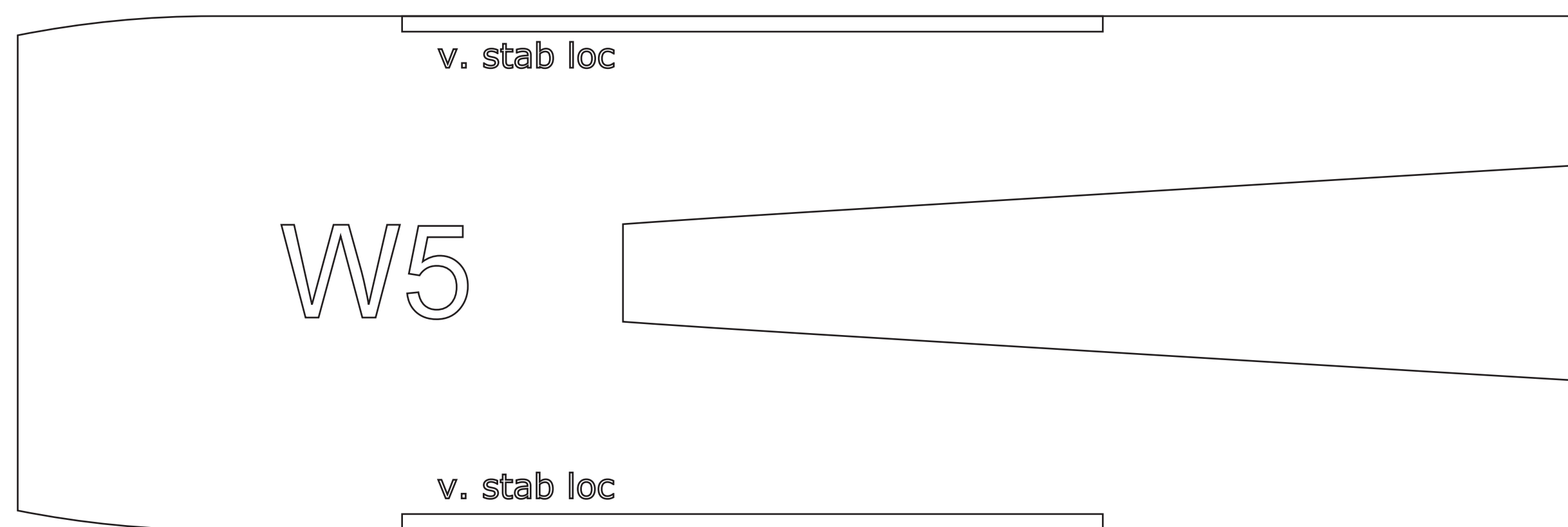

W5

v. stab loc

v. stab loc



f2 Low Fuse f1



W3

F2

F3

F1

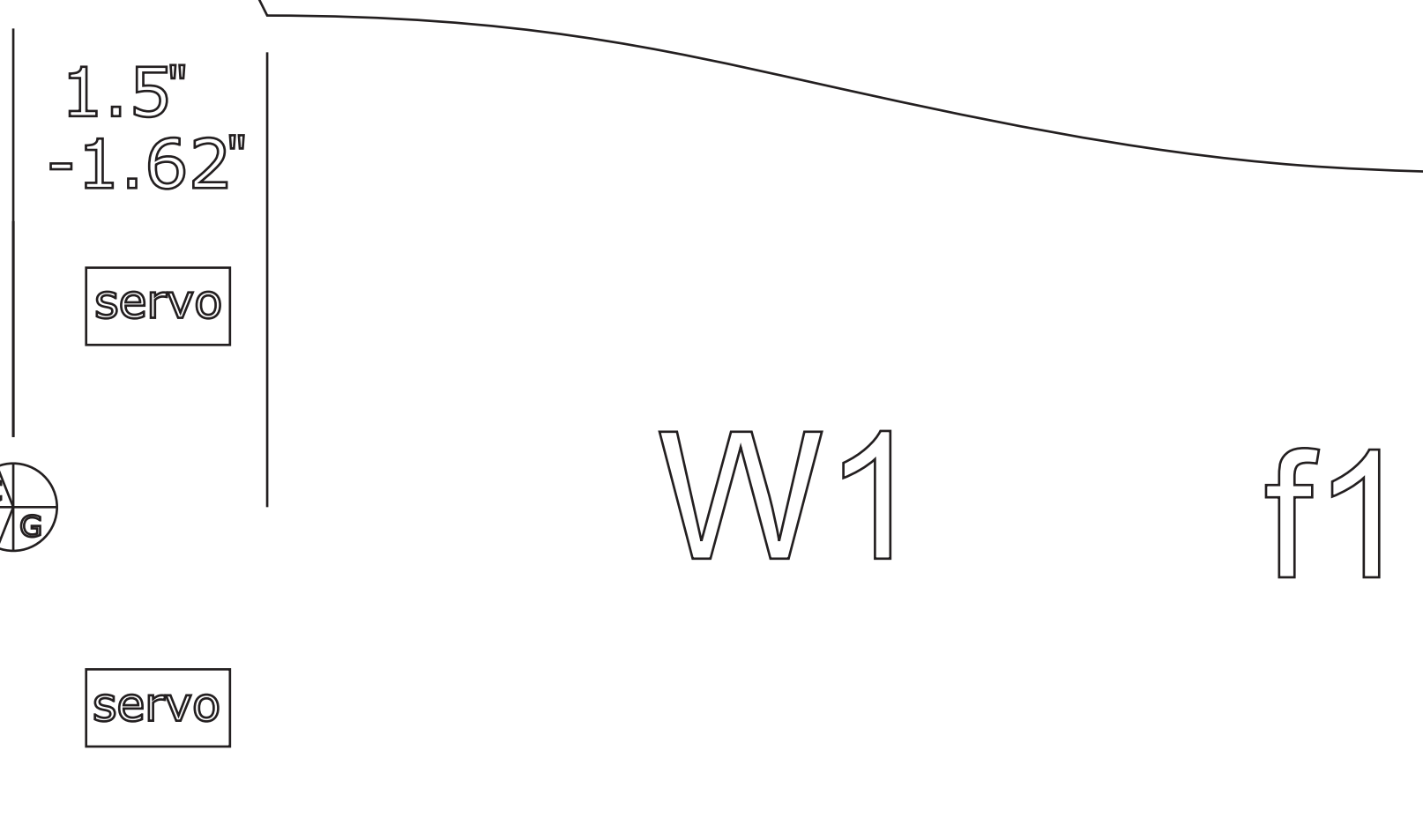

W1

f1

1.5" -1.62" servo

servo



W2

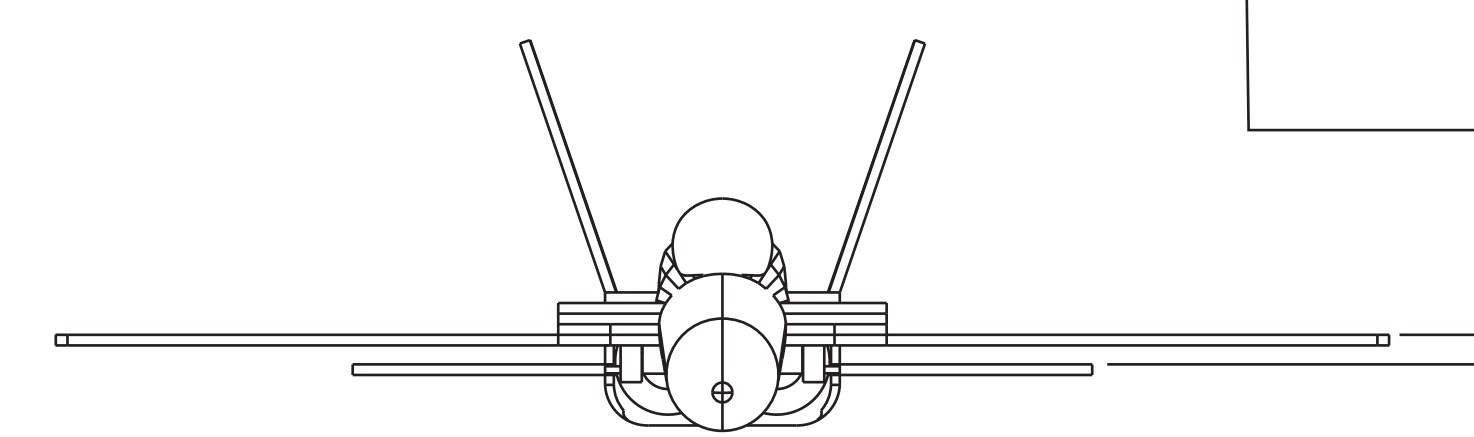

h stab .52" below wing

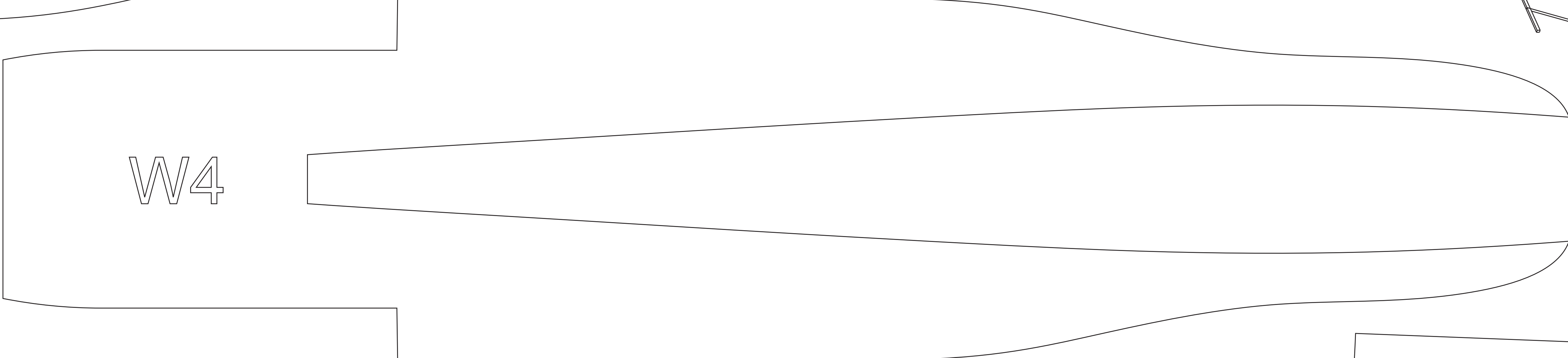

W4

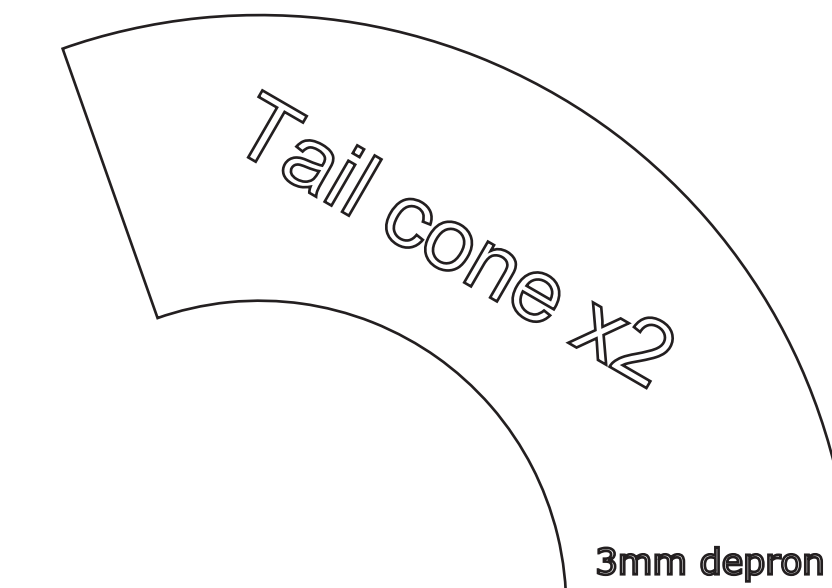
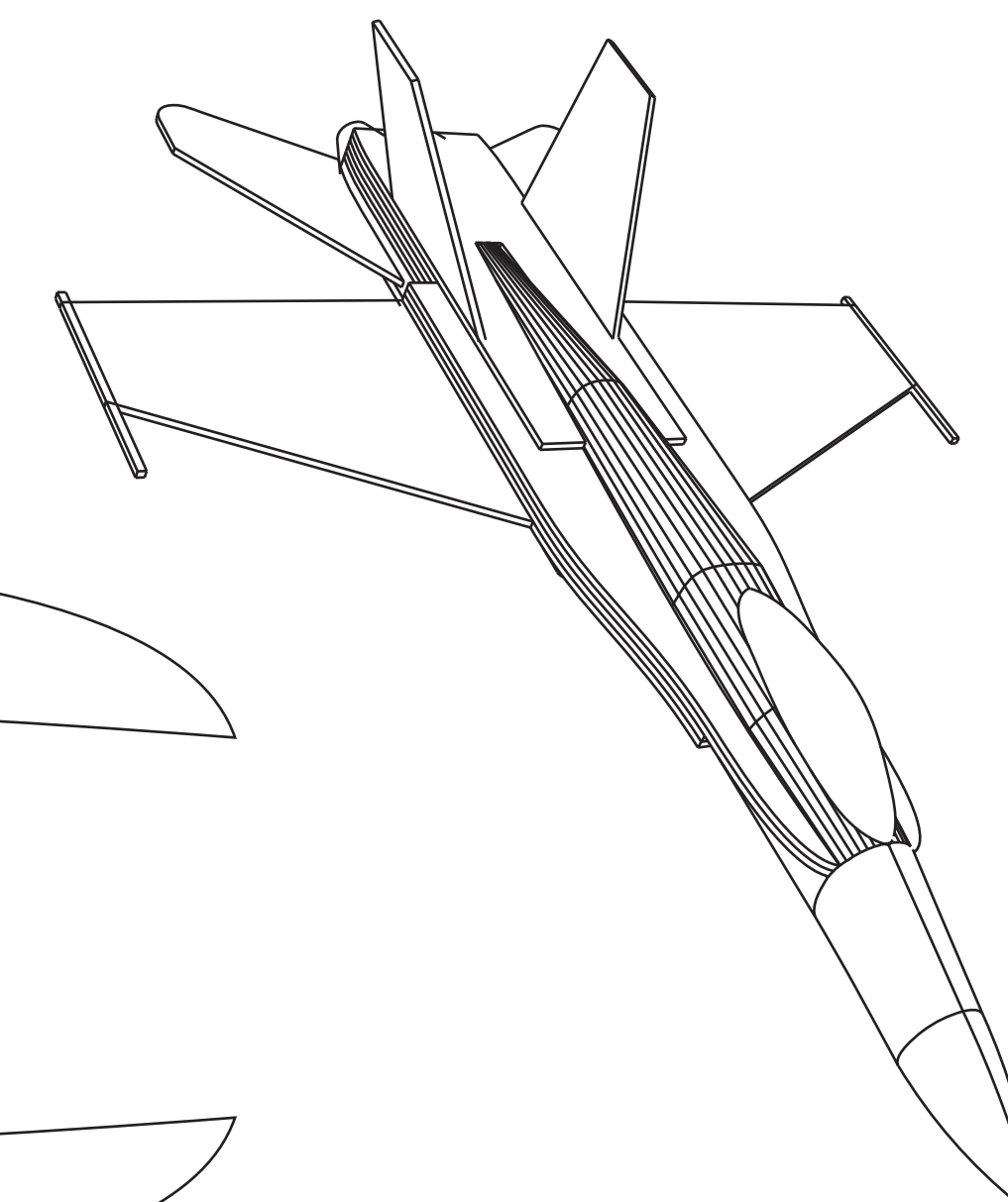
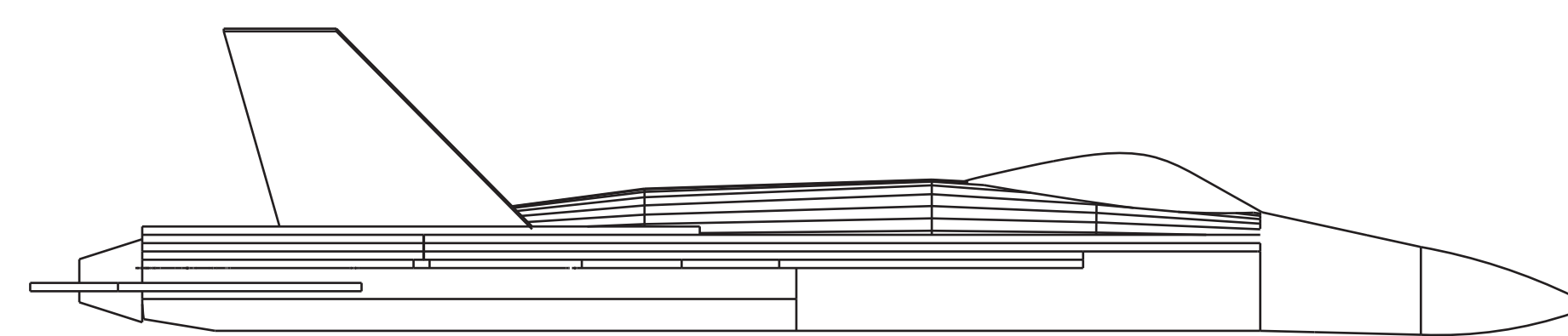

Tail cone x2

3mm depron

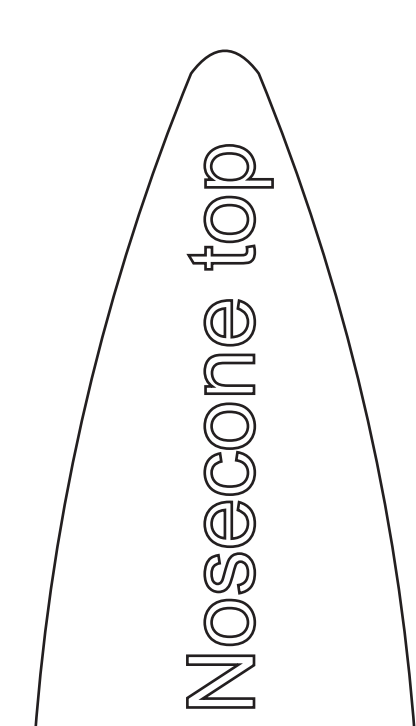

Nosecone top

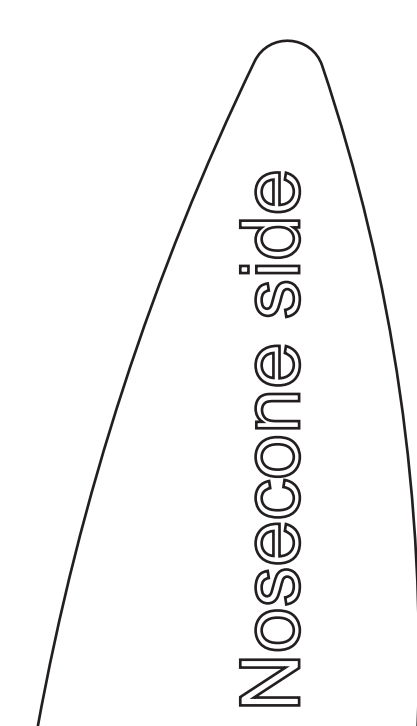

Nosecone side

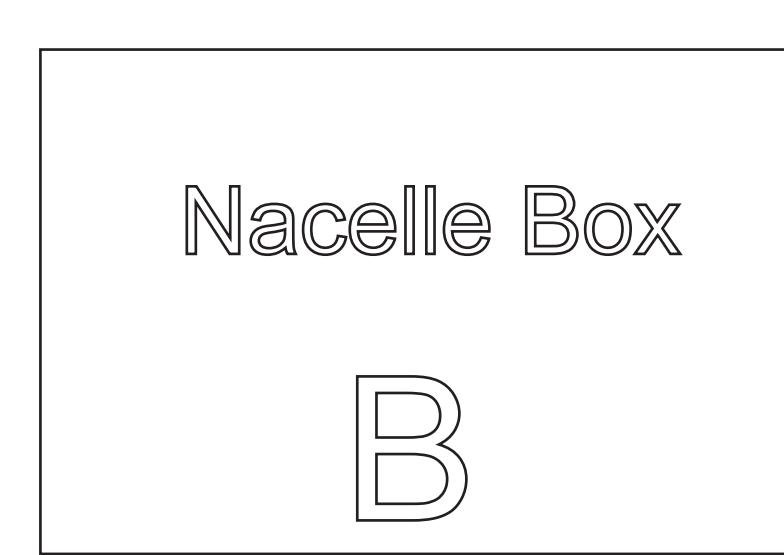

Nacelle Box B

B

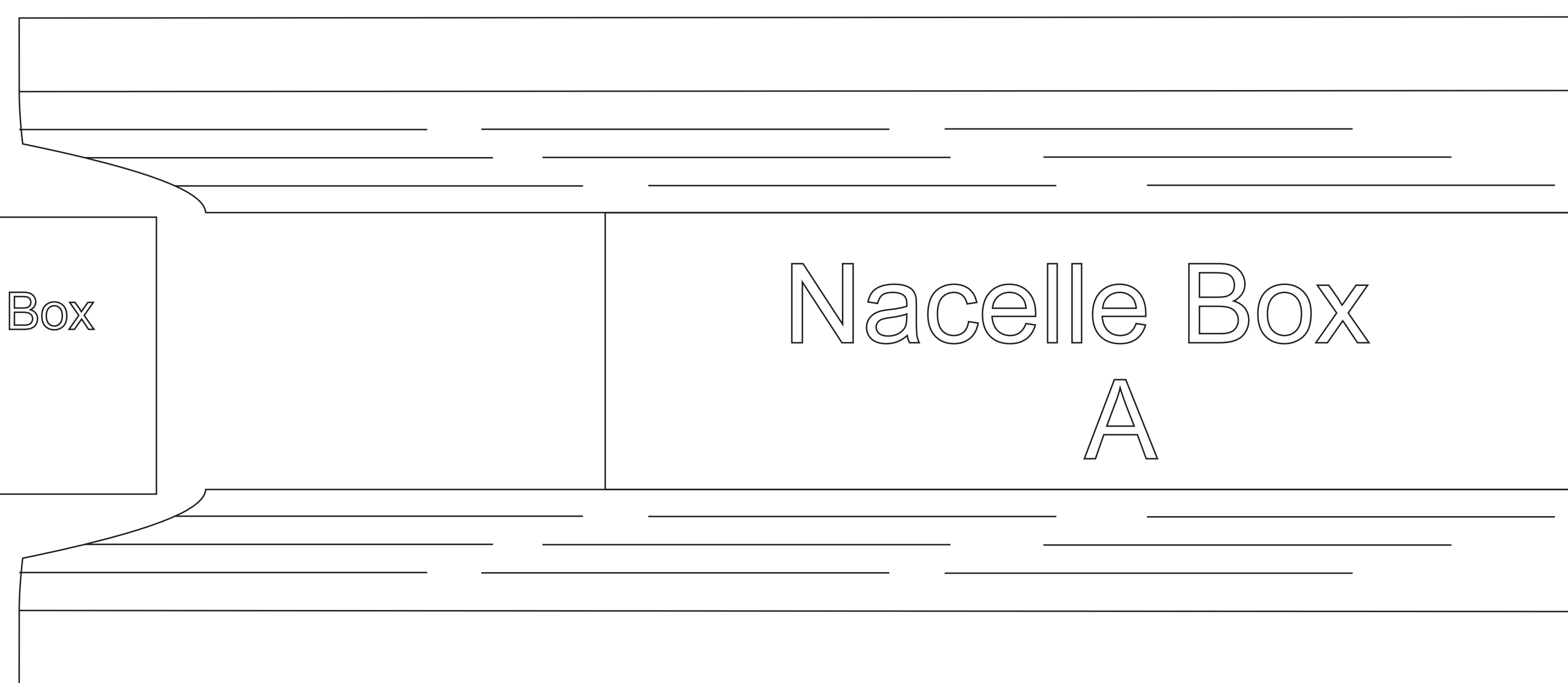

Nacelle Box A

A

MB F/A18 Hornet
 design by Al Sprosta 2004
 scale 1 inch
 for 1/4" - 3/8" Fanfold/Depron

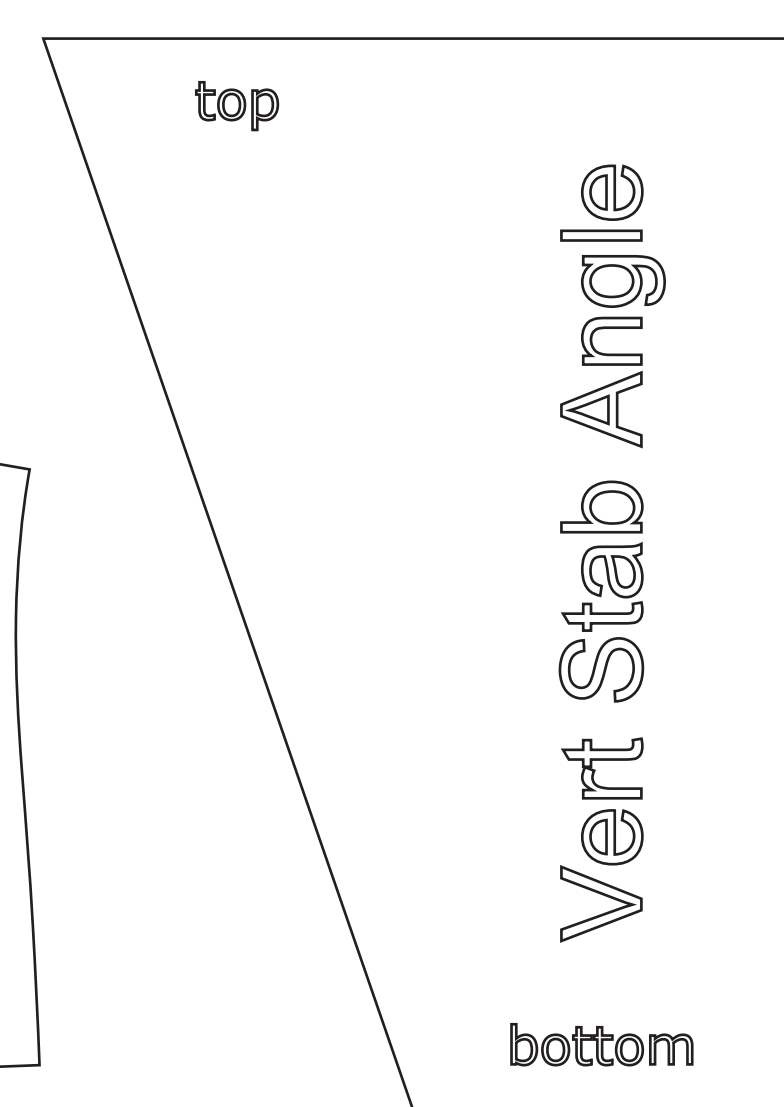

top

Vert Stab Angle

bottom